

Kitchen Sinks

COLLECTION

by BLEU PROVENCE



Bleu
PROVENCE 

Kitchen Sinks

COLLECTION

by BLEU PROVENCE

TRUE COLORS KITCHEN 60.....	PAG. 02
TRUE COLORS KITCHEN 90 ASYMMETRIC	PAG. 06
TRUE COLORS LITE 80 ASYMMETRIC	PAG. 09
TRUE COLORS KITCHEN 90.....	PAG. 10
SCEGLIERE IL COLORE - COLOR CHOICE - CHOIX DE COULEUR.....	PAG. 14
COOK 69 - COOK 76	PAG. 18
COOK 84 DOUBLE	PAG. 19
COOK 91 - COOK 91 DOUBLE.....	PAG. 20
BAKE 76 - BAKE 83	PAG. 24
STOVE 41 - STOVE 60	PAG. 28
STOVE 76 - STOVE 86 DOUBLE	PAG. 29
STOVE HOLE 41 - STOVE HOLE 60	PAG. 32
STOVE HOLE 76 - STOVE HOLE 86 DOUBLE	PAG. 33
DEEP 45 - DEEP 60	PAG. 34
SHINE 61 - SHINE 71	PAG. 36
TERRACOTTA	PAG. 38
LIVIA	PAG. 40
SABRI	PAG. 44
RUBINETTI - TAPS - ROBINETS.....	PAG. 48
ACCESSORI - ACCESSORIES - ACCESSOIRES	PAG. 52
FINITURE METALLI - METAL FINISHING - FINITION DE MÉTAUX... ..	PAG. 56



TRUE COLORS KITCHEN 60

ITA 100% ceramica, i lavelli da cucina True Colors sono il top dell'eleganza. Sia classici che moderni con la loro spalliera integrata, possono essere bianchi o colorati per dare ancora più personalità alla vostra cucina.

UK 100% ceramic, True Colors kitchen sinks are the ultimate in elegance. Both classic and modern with their integrated backsplash, they can be enameled white or colored to give even more personality to your kitchen.

FR 100% en céramique, les évier de cuisine True Colors sont le summum de l'élégance. A la fois classiques et modernes avec leur dosseret intégré, ils peuvent être émaillés blancs ou colorés pour donner encore plus de personnalité à votre cuisine.

TRUE COLORS KITCHEN 60



TRUE COLORS KITCHEN 60



ITA Mobili disponibili su richiesta.
Scelta colore lavabo a pagina 15.
UK Furniture available on request.
Various colours available on page 15.
FR Meuble disponible sur demande.
Choix des couleurs du lavabo page 15.

TRUE COLORS KITCHEN 60

ART. TCK60B - 60 cm

Lavello vasca singola
Single sink
Évier simple vasque

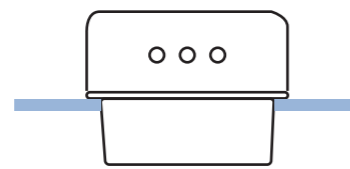

Installazione *sopra* il top di rifinitura
Installation *over* the top finishing
Installation *au-dessus* du top

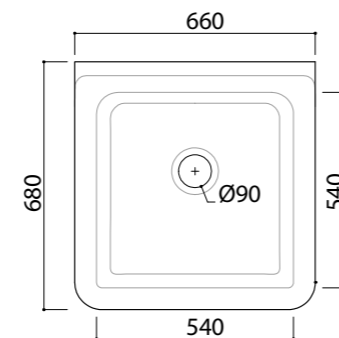
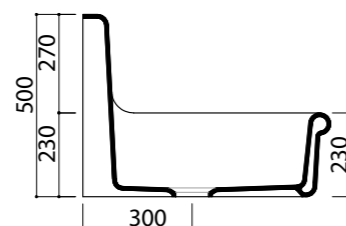
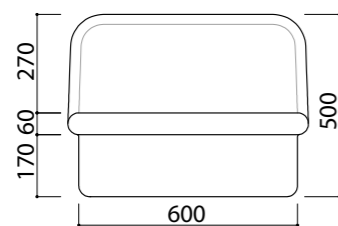
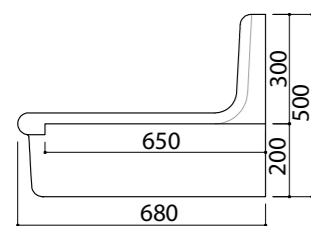

TRUE COLORS FURNITURE

ART. TCM60 - 90 cm

Mobile per True Colors 60
Furniture for True Colors 60cm
Meuble pour True Colors 60cm

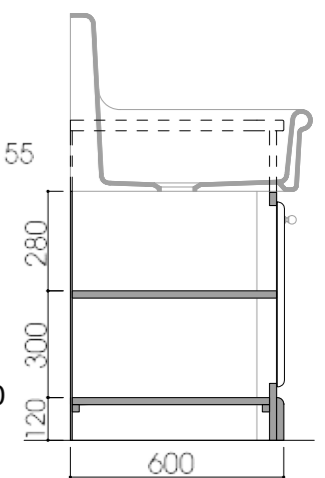
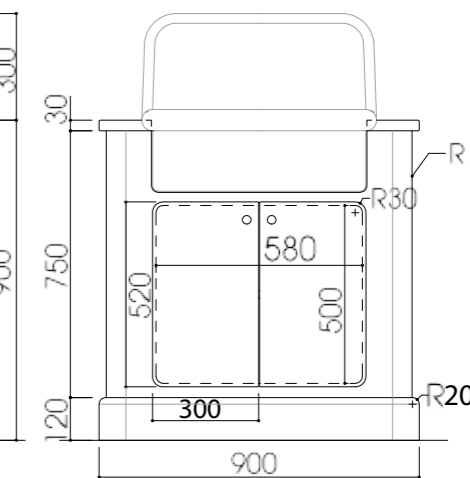
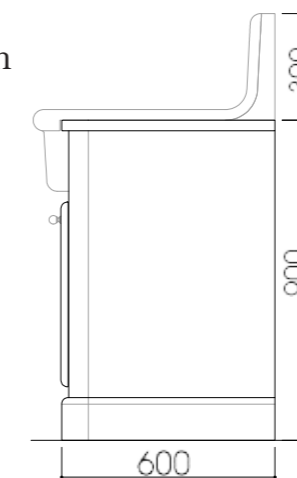
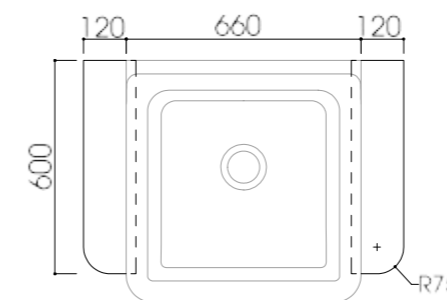



TRUE COLORS KITCHEN 90 ASYMMETRIC

ITA 100% ceramica, i lavelli da cucina True Colors sono il top dell'eleganza. Sia classici che moderni con la loro spalliera integrata, possono essere bianchi o colorati per dare ancora più personalità alla vostra cucina.

UK 100% ceramic, True Colors kitchen sinks are the ultimate in elegance. Both classic and modern with their integrated backsplash, they can be enameled white or colored to give even more personality to your kitchen.

FR 100% en céramique, les éviers de cuisine True Colors sont le summum de l'élégance. A la fois classiques et modernes avec leur dosseret intégré, ils peuvent être émaillés blancs ou colorés pour donner encore plus de personnalité à votre cuisine.

TRUE COLORS KITCHEN 90 ASYMMETRIC



TCK90B/A - cm.90



SPAL90 - cm.90



TCK190B/A - cm.90

TRUE COLORS LITE 80 ASYMMETRIC



TRUE COLORS KITCHEN 90 ASYMMETRIC

ART. TCK90B/A - 90 cm / ART. TCK190B/A - 90 cm

ART. SPAL90 - 90 cm

Lavello vasca singola con gocciolatoio

Single sink with drainboard

Évier simple avec égouttoir

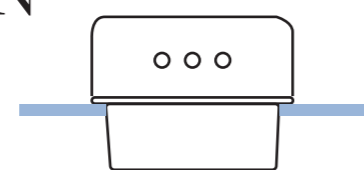

Installazione sopra il top di rifinitura
Installation over the top finishing
Installation au-dessus du top

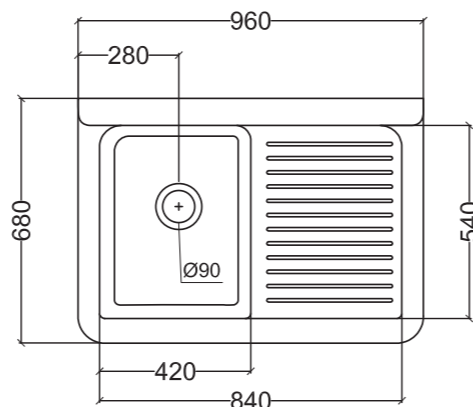
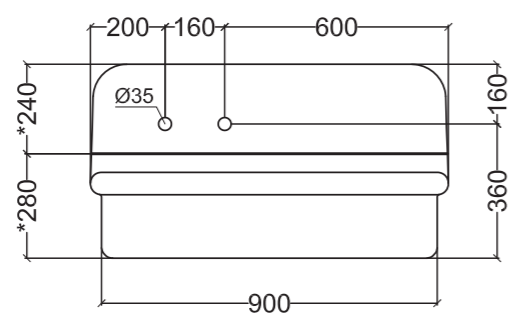
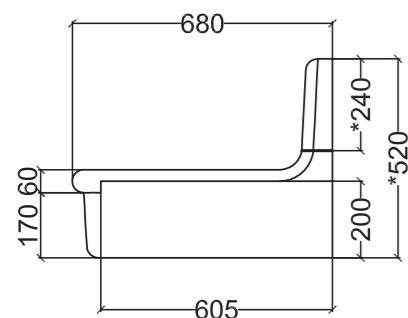
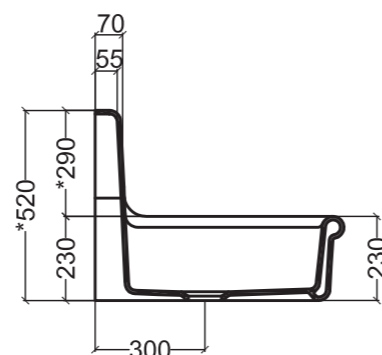

TRUE COLORS LITE 80 ASYMMETRIC

ART. TC2LA80B - 80cm / ART. TC239B

Lavello vasca singola 80cm asimmetrico con coppia gambe ceramiche

Single sink asymmetric 80cm with 2 ceramic feet

Évier simple asymétrique 80cm avec 2 jambes en céramique

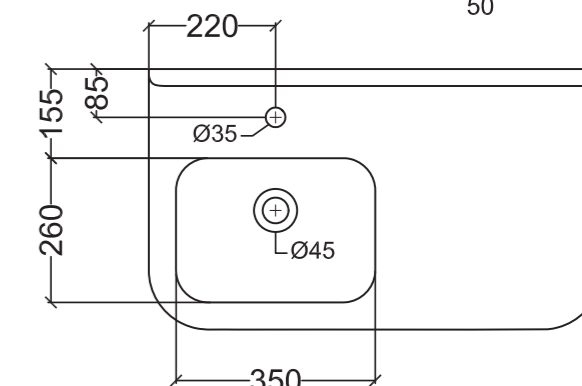
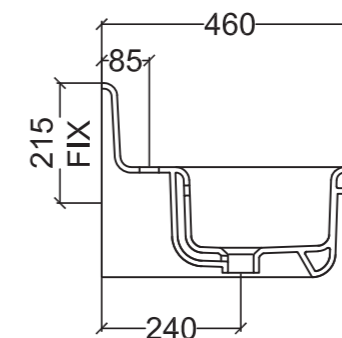
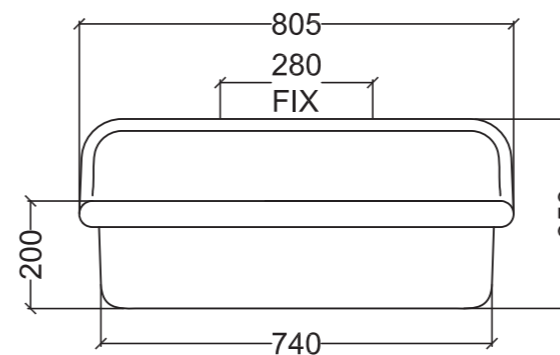
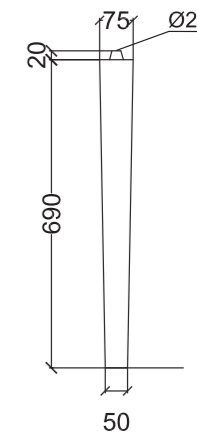



TRUE COLORS KITCHEN 90

ITA 100% ceramica, i lavelli da cucina True Colors sono il top dell'eleganza. Sia classici che moderni con la loro spalliera integrata, possono essere bianchi o colorati per dare ancora più personalità alla vostra cucina.

UK 100% ceramic, True Colors kitchen sinks are the ultimate in elegance. Both classic and modern with their integrated backsplash, they can be enameled white or colored to give even more personality to your kitchen.

FR 100% en céramique, les évier de cuisine True Colors sont le summum de l'élégance. A la fois classiques et modernes avec leur dosseret intégré, ils peuvent être émaillés blancs ou colorés pour donner encore plus de personnalité à votre cuisine.

TRUE COLORS KITCHEN 90



TCK90B - cm.90

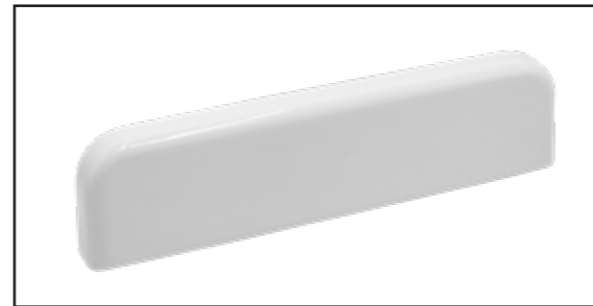

SPAL90 - cm.90



TCK190B - cm.90

TRUE COLORS KITCHEN 90



ITA Mobili disponibili su richiesta.
Scelta colore lavabo a pagina 14.
UK Furniture available on request.
Various colours available on page 14.
FR Meuble disponible sur demande.
Choix des couleurs du lavabo page 14.

TRUE COLORS KITCHEN 90

ART. TCK90B - 90 cm / ART. TCK190B - 90 cm

ART. SPAL90 - 90 cm

Lavello vasca doppia

Double sink

Évier double

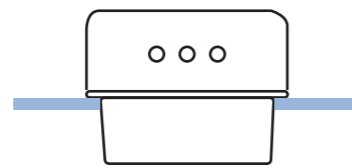

Installazione sopra il top di rifinitura
Installation over the top finishing
Installation au-dessus du top

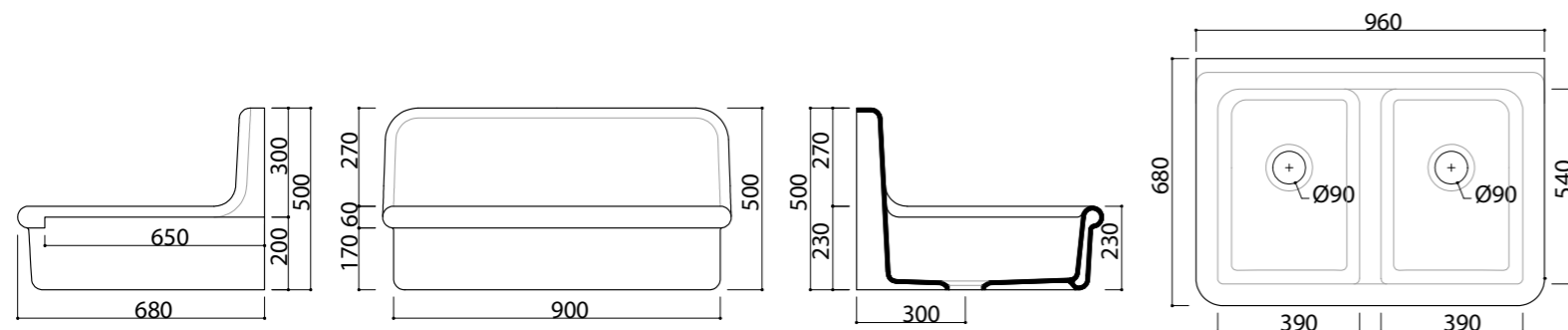

TRUE COLORS FURNITURE

ART. TCM90 - 120 cm

Mobile per True Colors 90cm (doppio o asimmetrico)

Furniture for True Colors 90cm (double or asymmetric)

Meuble pour True Colors 90cm

(double ou avec égouttoir)

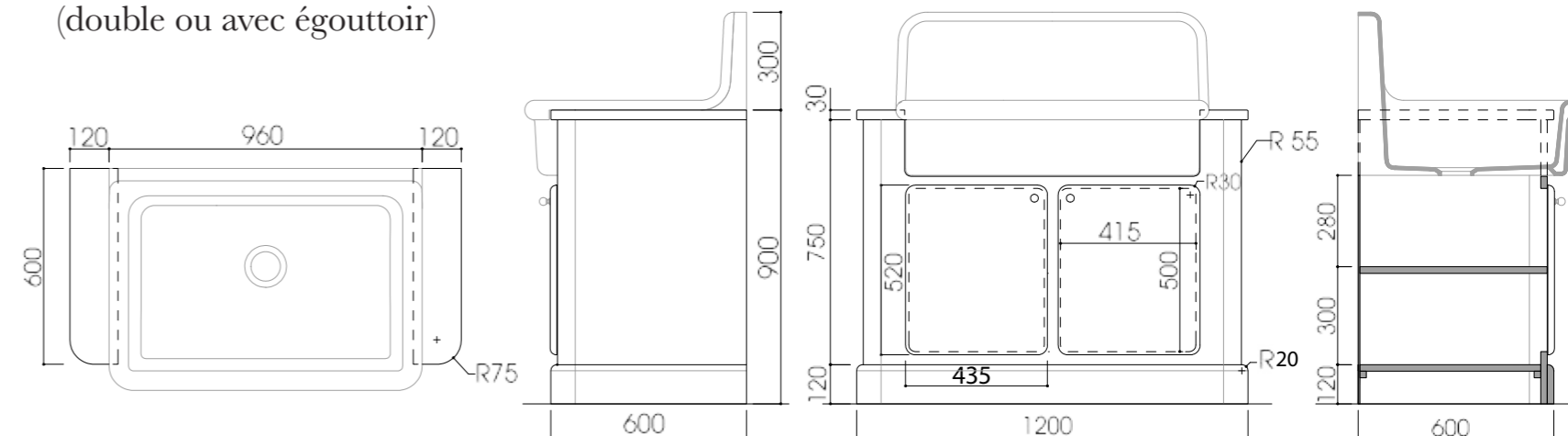

SCEGLIERE IL COLORE

Choose the color
Choisir la couleur

BIANCO
White
Blanc



INTERNO ED
ESTERNO NERO
Interior &
exterior black
Intérieur et
extérieur noir





COOK

ITA La serie Cook è composta da lavelli in ceramica con una vasca larga e profonda e con uno scarico centrale che offre un confort totale per il vostro ambiente cucina. La reversibilità nel design permette una scelta creativa ed estetica. I nostri lavelli sono finiti con smalti resistenti agli acidi, agli alcalini, ai detersivi e alle macchie.

UK The Cook serie is composed of ceramic sinks with a wide, deep bowl and central drain, offering the right comfort to enjoy your kitchen space. The double possibility of installation allows a creative and aesthetic choice. Our sinks also uses a special glaze resistant to acids, alkalines, detergents and stains.

FR La série Cook est composée d'éviers en céramique avec une vasque large et profonde ainsi qu'un vidage central assurant un confort maximal pour apprécier votre espace de cuisine. La double possibilité d'installation permet un choix créatif et esthétique. Nos éviers utilisent aussi un émail résistant aux acides, alcalins, détergents et taches.

COOK 69-76

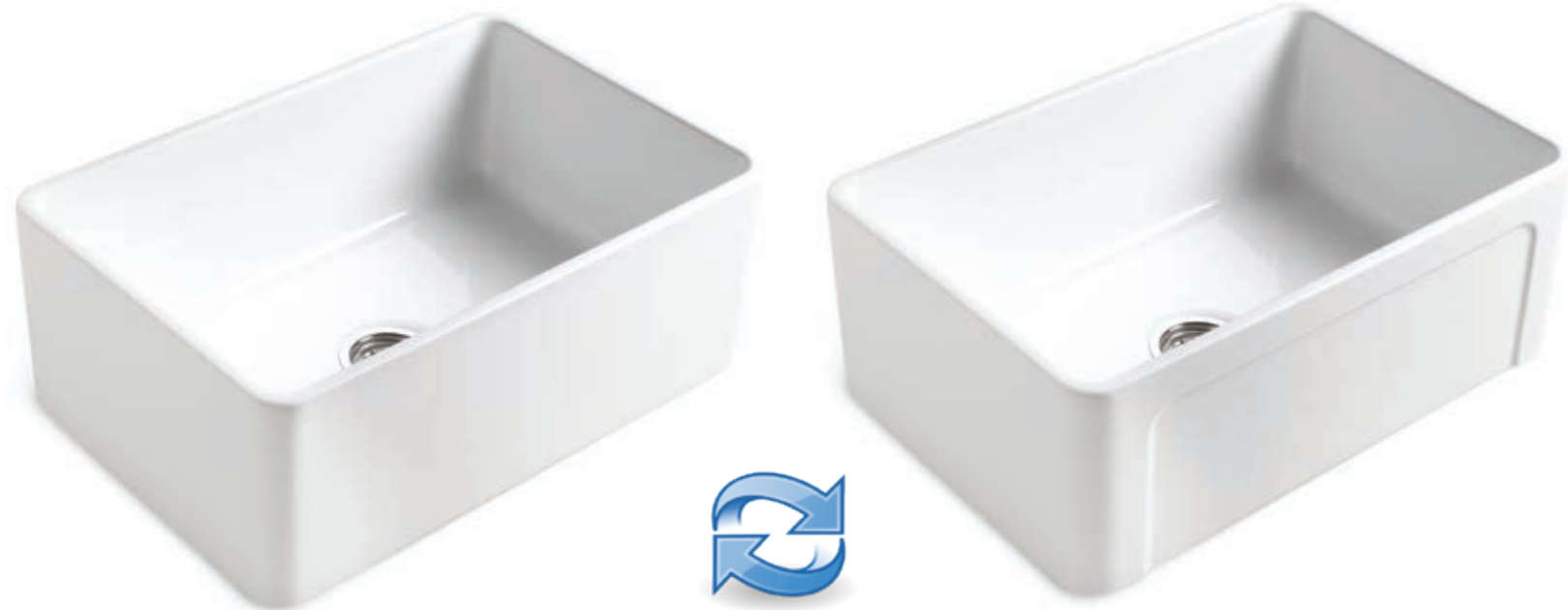

REVERSIBILE
REVERSIBLE
RÉVERSIBLE

Lato piatto – flat side – côté plat

Lato decorato – decorated side – côté décoré

COOK 84 DOUBLE



REVERSIBILE
REVERSIBLE
RÉVERSIBLE

COOK 69

ART. LK02 – 68,6x48,5 cm - 32 kg

Lavabo reversibile
Reversible sink
Évier réversible

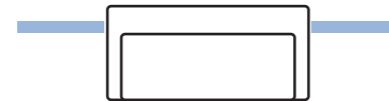

Installazione sopra il top di rifinitura
Installation over the top finishing
Installation au-dessus du top

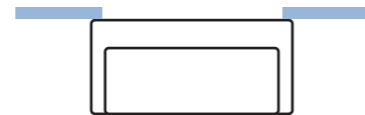

Installazione sotto il top di rifinitura
Installation under the top finishing
Installation au-dessous du top

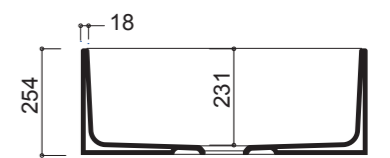
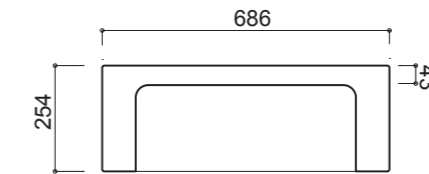
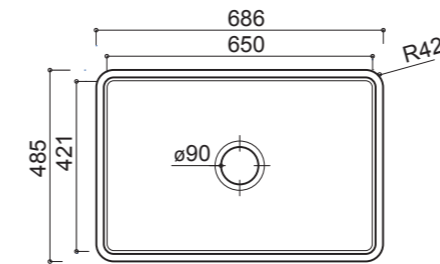

COOK 76

ART. LK03 – 76,2x48,5 cm - 38 kg

Lavabo reversibile
Reversible sink
Évier réversible

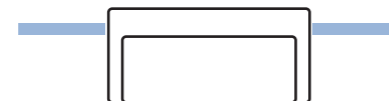

Installazione sopra il top di rifinitura
Installation over the top finishing
Installation au-dessus du top

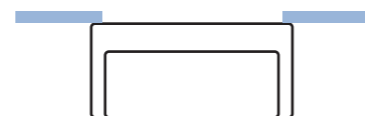

Installazione sotto il top di rifinitura
Installation under the top finishing
Installation au-dessous du top

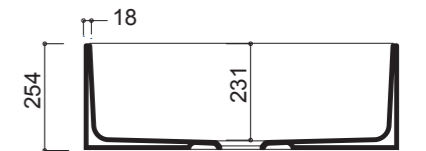
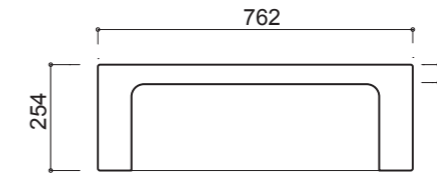
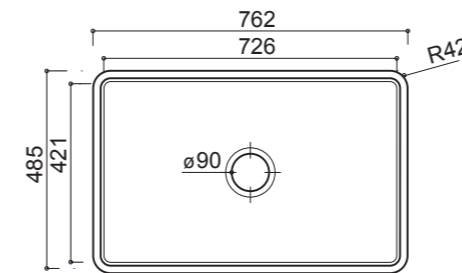

COOK 84 DOUBLE

ART. LK21 – 83,8x48,5 cm - 40 kg

Lavabo doppio reversibile
Reversible double sink
Évier double vasque réversible

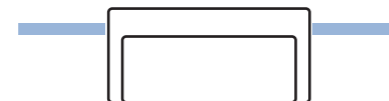

Installazione sopra il top di rifinitura
Installation over the top finishing
Installation au-dessus du top

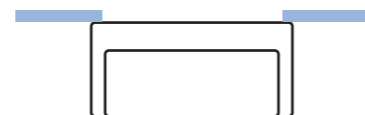

Installazione sotto il top di rifinitura
Installation under the top finishing
Installation au-dessous du top

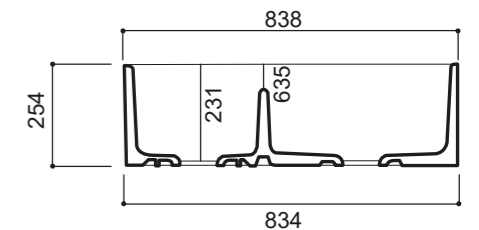
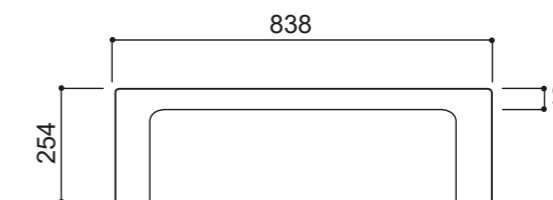
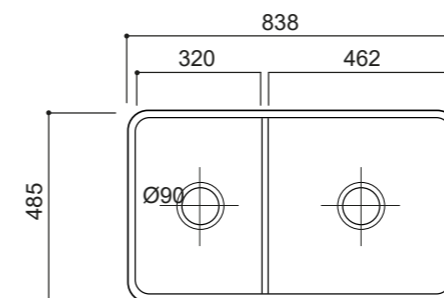

COOK 91



REVERSIBILE
REVERSIBLE
RÉVERSIBLE



ITA Disponibile anche con bordino per appoggio tagliere.
UK Also available with inside ledge to put cutting board.
FR Aussi disponible avec rebord pour poser une planche à découper.

Lato decorato – decorated side – côté décoré

Lato decorato – decorated side – côté décoré

COOK 91

ART. LK22 – 91,4x48,5 cm - 42 kg

Lavabo reversibile
Reversible sink
Évier réversible

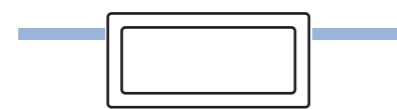

Installazione sopra il top di rifinitura
Installation over the top finishing
Installation au-dessus du top

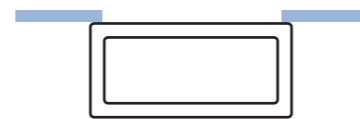

Installazione sotto il top di rifinitura
Installation under the top finishing
Installation au-dessous du top

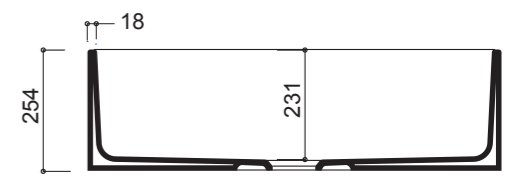
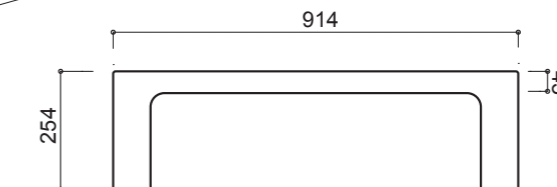
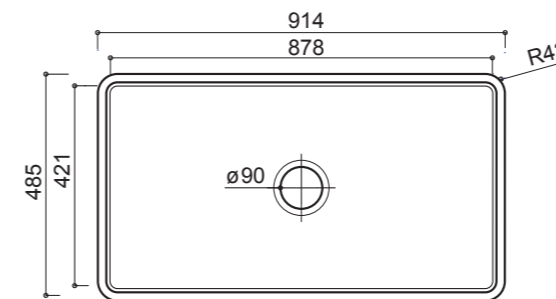

COOK 91 DOUBLE

ART. LK23 – 91,4x48,8 cm - 40 kg

Lavabo doppio reversibile
con bordo interno
Reversible double sink with interior edge
Évier réversible avec rebord intérieur.

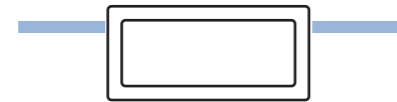

Installazione sopra il top di rifinitura
Installation over the top finishing
Installation au-dessus du top

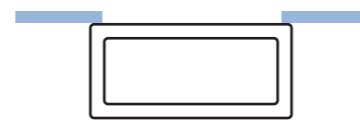

Installazione sotto il top di rifinitura
Installation under the top finishing
Installation au-dessous du top

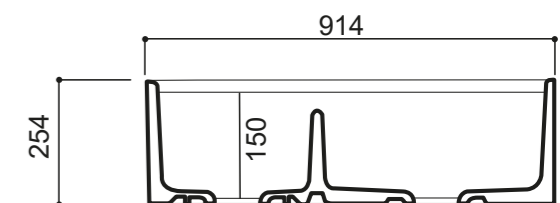
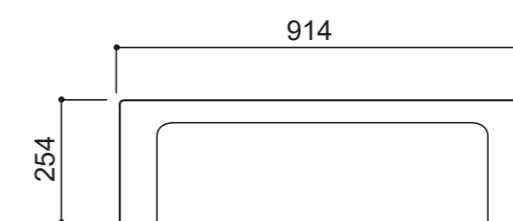
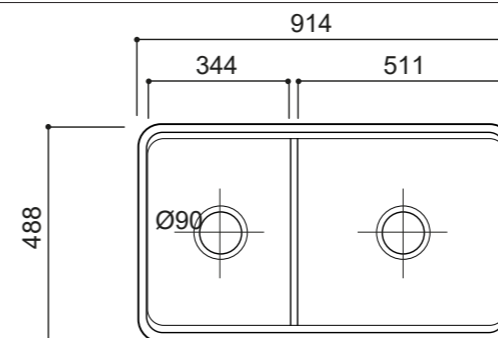



BAKE



Lato piatto – flat side – côté plat



REVERSIBILE
REVERSIBLE
RÉVERSIBLE

BAKE



Lato decorato – decorated side – côté décoré

BAKE 76

ART. LK04 – 76,2x46 cm - 35 kg

Lavabo reversibile
Reversible sink
Évier réversible

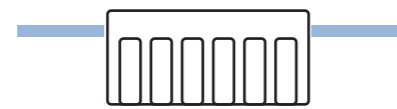

Installazione sopra il top di rifinitura
Installation over the top finishing
Installation au-dessus du top

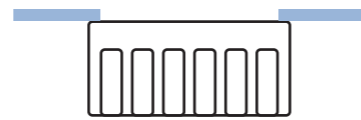

Installazione sotto il top di rifinitura
Installation under the top finishing
Installation au-dessous du top

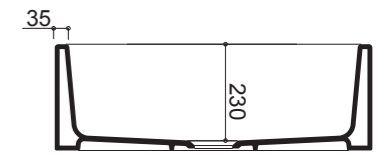
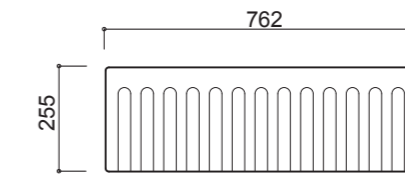
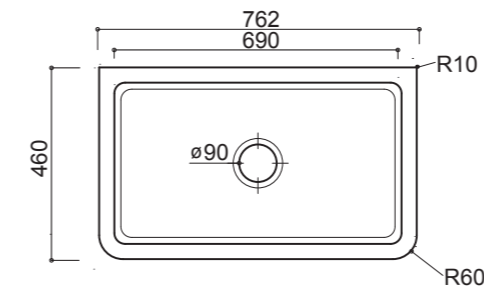

BAKE 83

ART. LK05 – 83,8x46 cm - 40 kg

Lavabo reversibile
Reversible sink
Évier réversible

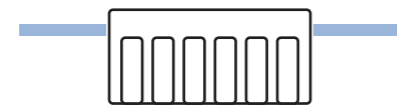

Installazione sopra il top di rifinitura
Installation over the top finishing
Installation au-dessus du top

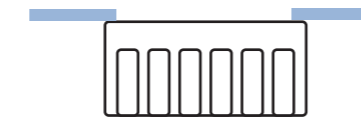

Installazione sotto il top di rifinitura
Installation under the top finishing
Installation au-dessous du top

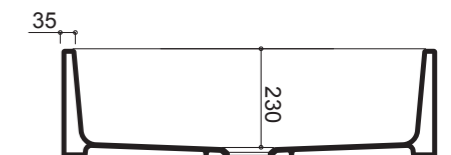
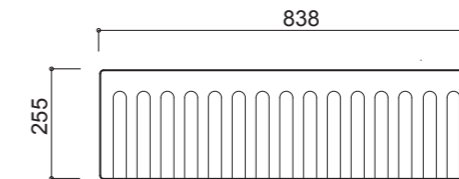
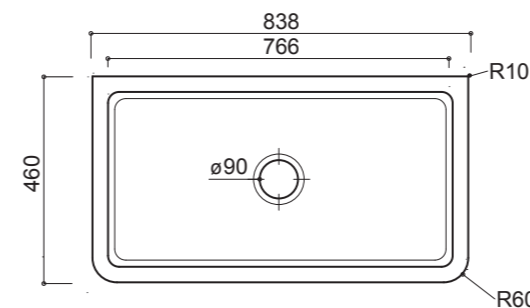



STOVE 41-60



REVERSIBILE
SOPRA/SOTTO PIANO
POSSIBLE CHOICE: INSET
OR UNDERCOUNTER
AU CHOIX: SEMI ENCASTRÉ
OU SOUS PLAN



STOVE 76-86



STOVE 41

ART. LK06 - 41x50,5 cm - 14 kg



Reversibile sopra/sotto piano
Possible choice: inset or undercounter
Au choix: semi encastré ou sous plan



Installazione sopra il top di rifinitura
Installation over the top finishing
Installation au-dessus du top



Installazione sotto il top di rifinitura
Installation under the top finishing
Installation au-dessous du top

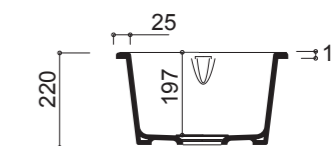
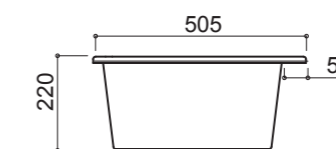
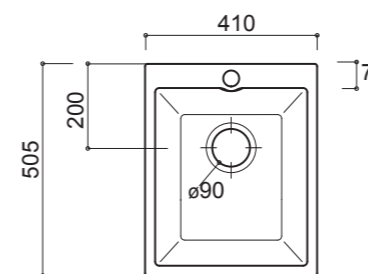

STOVE 60

ART. LK07 - 60x50,5 cm - 19 kg



Reversibile sopra/sotto piano
Possible choice: inset or undercounter
Au choix: semi encastré ou sous plan



Installazione sopra il top di rifinitura
Installation over the top finishing
Installation au-dessus du top

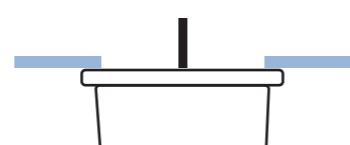

Installazione sotto il top di rifinitura
Installation under the top finishing
Installation au-dessous du top

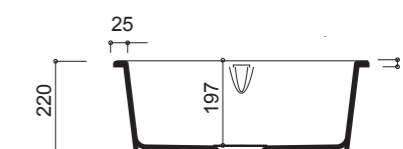
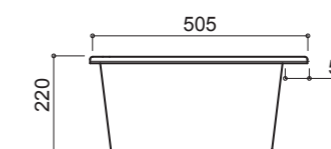
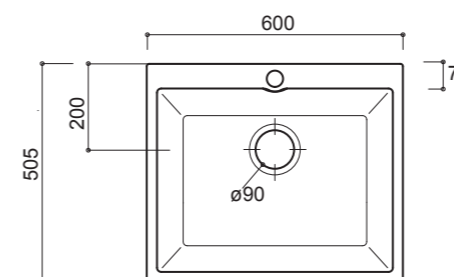

STOVE 76

ART. LK12 - 76x51 cm - 18 kg



Reversibile sopra/sotto piano
Possible choice: inset or undercounter
Au choix: semi encastré ou sous plan



Installazione sopra il top di rifinitura
Installation over the top finishing
Installation au-dessus du top



Installazione sotto il top di rifinitura
Installation under the top finishing
Installation au-dessous du top

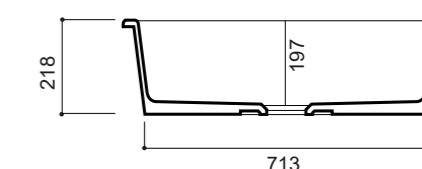
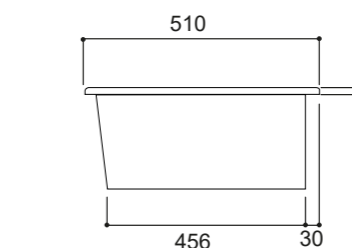
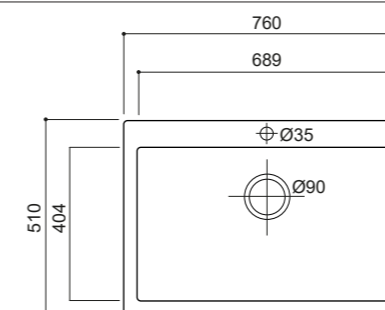

STOVE 86 DOUBLE

ART. LK13 - 86x51 cm - 22 kg



Doppio reversibile sopra/sotto piano
Possible choice: inset or undercounter double sink
Au choix: semi encastré ou sous plan évier
double vasque



Installazione sopra il top di rifinitura
Installation over the top finishing
Installation au-dessus du top



Installazione sotto il top di rifinitura
Installation under the top finishing
Installation au-dessous du top

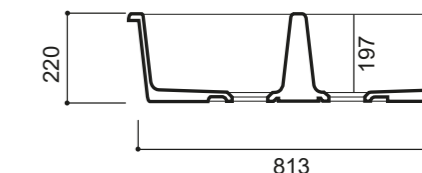
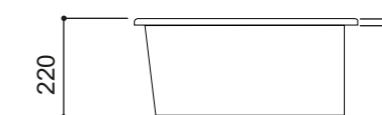
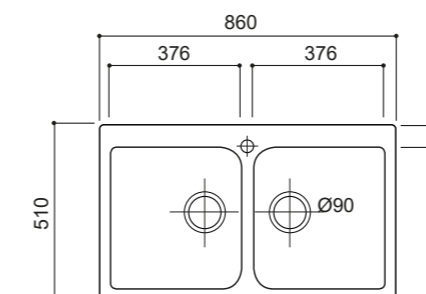



STOVE HOLE

ITA Il lavello Stove propone un design semplice ma efficace. Una vasca profonda e un bordo fine permettono un risultato semi incasso perfetto, con possibilità di installare un rubinetto nella parte ceramica retrostante.

UK The Stove sink boasts a minimal but nice design. A deep bowl with thin outline allows a perfect overtop installation, installation with also the possibility to put a faucet on the ceramic edge.

FR L'évier Stove propose un design simple mais efficace. Une vasque profonde et un rebord fin permettent un rendu semi encastré parfait avec possibilité d'installer un robinet sur la partie arrière de la céramique.

STOVE HOLE 41-60



REVERSIBILE
SOPRA/SOTTO PIANO
POSSIBLE CHOICE: INSET
OR UNDERCOUNTER
AU CHOIX: SEMI ENCASTRÉ
OU SOUS PLAN



STOVE HOLE 76-86



STOVE HOLE 41

ART. LK08 - 41x50,5 cm - 14 kg



Reversibile sopra/sotto piano
Possible choice: inset or undercounter
Au choix: semi encastré ou sous plan

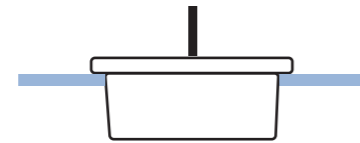

Installazione sopra il top di rifinitura
Installation over the top finishing
Installation au-dessus du top

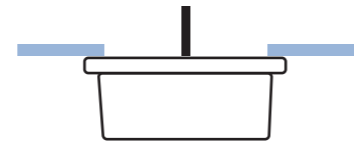

Installazione sotto il top di rifinitura
Installation under the top finishing
Installation au-dessous du top

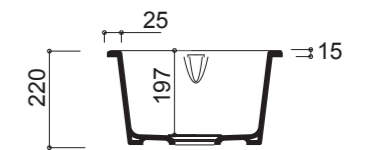
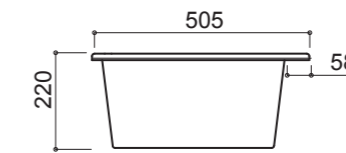
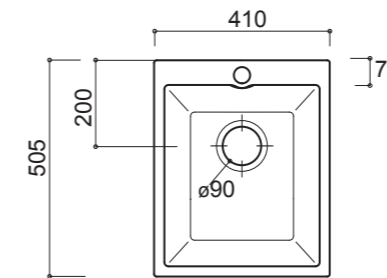

STOVE HOLE 60

ART. LK09 - 60x50,5 cm - 19 kg



Reversibile sopra/sotto piano
Possible choice: inset or undercounter
Au choix: semi encastré ou sous plan

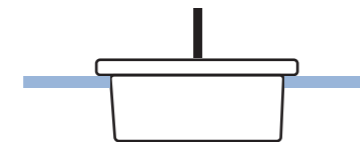

Installazione sopra il top di rifinitura
Installation over the top finishing
Installation au-dessus du top

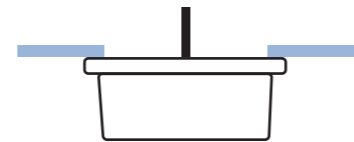

Installazione sotto il top di rifinitura
Installation under the top finishing
Installation au-dessous du top

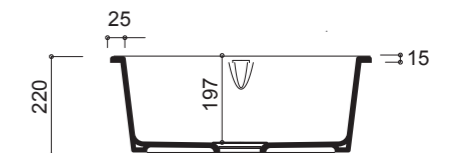
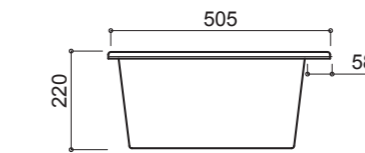
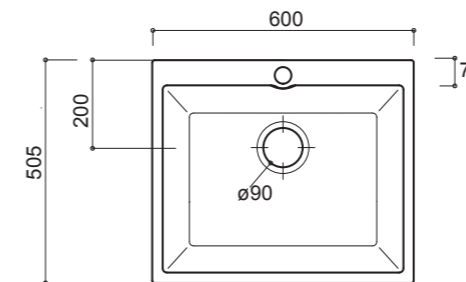

STOVE HOLE 76

ART. LK14 - 76x51 cm - 18 kg



Reversibile sopra/sotto piano
Possible choice: inset or undercounter
Au choix: semi encastré ou sous plan

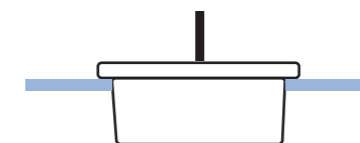

Installazione sopra il top di rifinitura
Installation over the top finishing
Installation au-dessus du top



Installazione sotto il top di rifinitura
Installation under the top finishing
Installation au-dessous du top

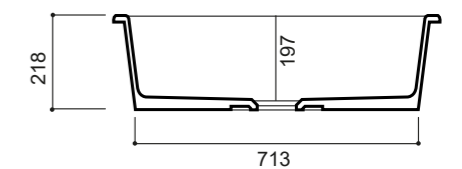
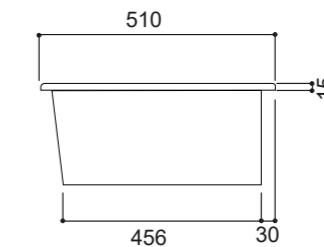
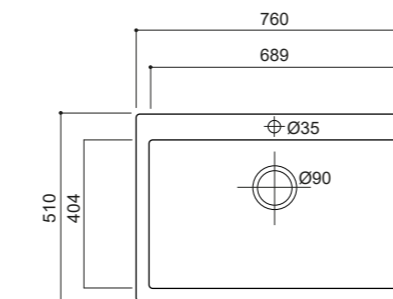

STOVE HOLE 86 DOUBLE

ART. LK15 - 86x51 cm - 22 kg



Doppio reversibile sopra/sotto piano
Possible choice: inset or undercounter double sink
Au choix: semi encastré ou sous plan évier
double vasque

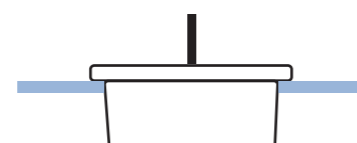

Installazione sopra il top di rifinitura
Installation over the top finishing
Installation au-dessus du top

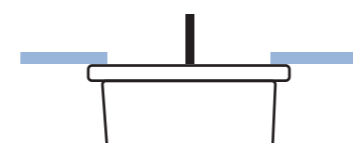

Installazione sotto il top di rifinitura
Installation under the top finishing
Installation au-dessous du top

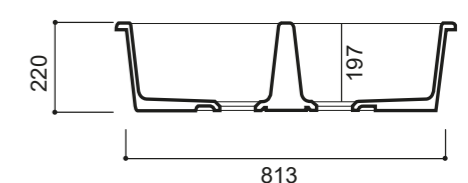
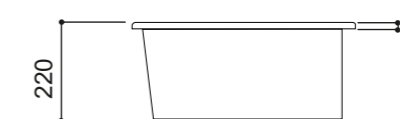
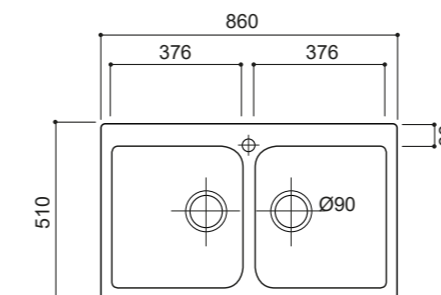

DEEP 45



DEEP 60



DEEP 45

ART. LK10 - 45x51 cm - 14 kg



Lavello sopraiano incasso con porta lavapanni

Undermount sink with notch for wooden board

Evier sous plan avec encoche pour planche en bois

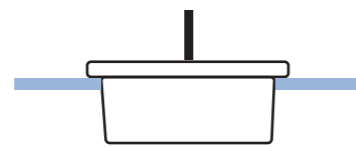

Installazione sopra il top di rifinitura
Installation over the top finishing
Installation au-dessus du top

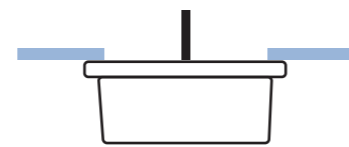

Installazione sotto il top di rifinitura
Installation under the top finishing
Installation au-dessous du top

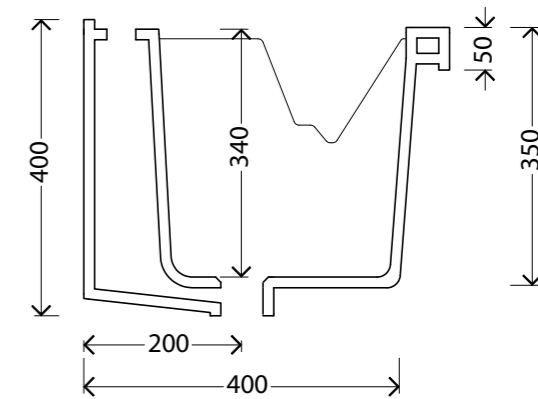
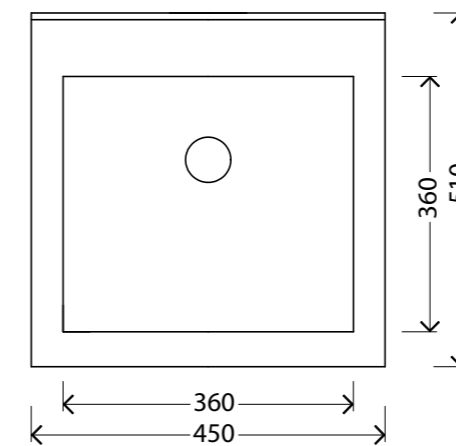

DEEP 60

ART. LK11 - 60x50 cm - 19 kg



Lavello sopraiano incasso con porta lavapanni

Undermount sink with notch for wooden board

Evier sous plan avec encoche pour planche en bois

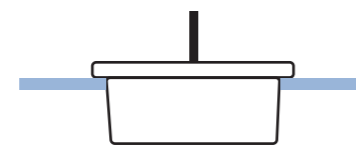

Installazione sopra il top di rifinitura
Installation over the top finishing
Installation au-dessus du top

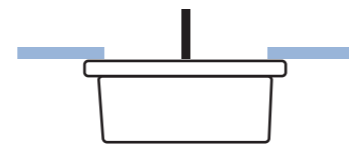

Installazione sotto il top di rifinitura
Installation under the top finishing
Installation au-dessous du top

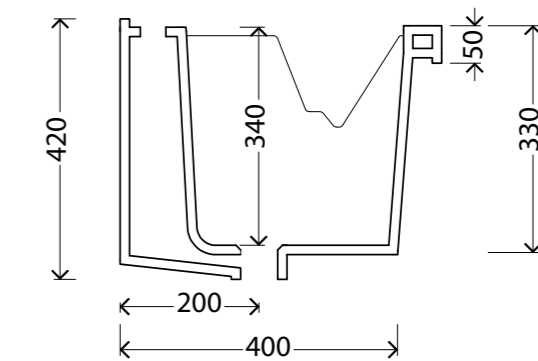
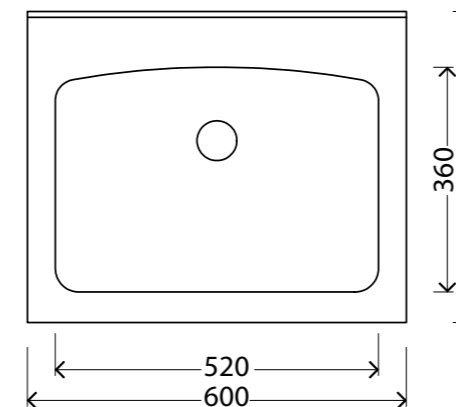

SHINE 61



SHINE 71



SHINE 61

ART. LK16 - 61x51 cm - 22kg



Lavello incasso/appoggio
Lavabo à encastrer ou à poser (au choix)
Inset or countertop sink

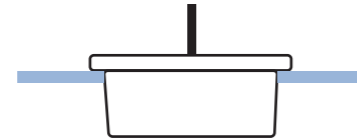

Installazione incasso
Installation inset
Installation à encastrer

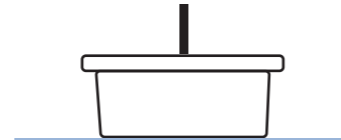

Installazione sopra il top di rifinitura
Installation over the top finishing
Installation au-dessus du top

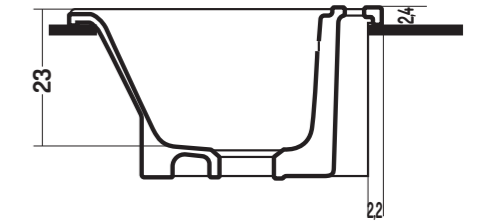
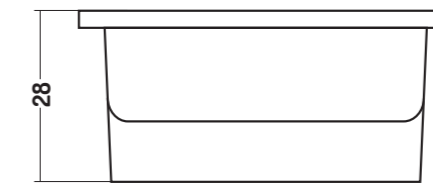
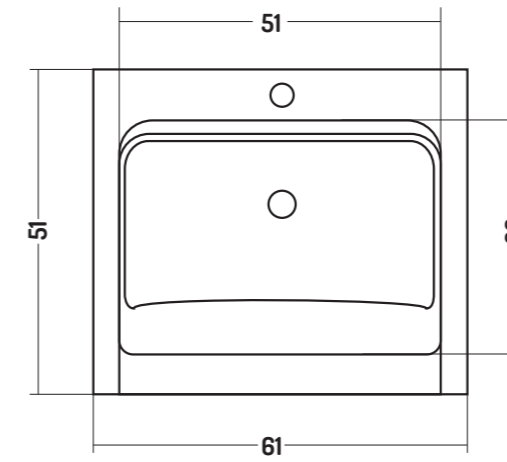

SHINE HOLE 61

ART. LK17 - 61x51 cm - 22 kg



Lavello incasso/appoggio con foro rubinetto
Lavabo à encastrer ou à poser (au choix) avec trou pour robinet
Inset or countertop sink with tap hole

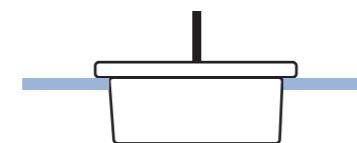

Installazione incasso
Installation inset
Installation à encastrer

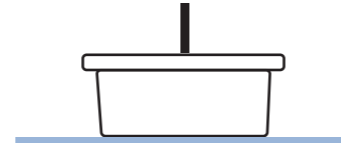

Installazione sopra il top di rifinitura
Installation over the top finishing
Installation au-dessus du top

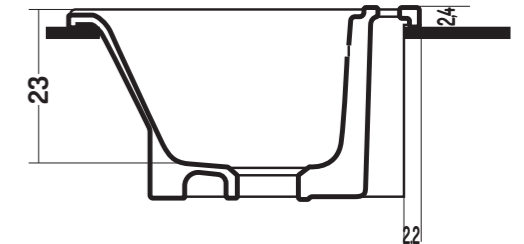
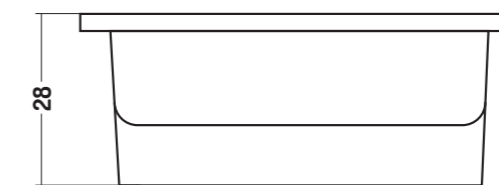
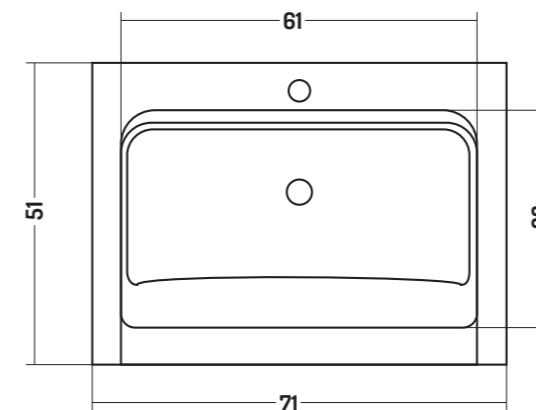

SHINE 71

ART. LK18 - 71x51 cm - 19 kg



Lavello incasso/appoggio
Lavabo à encastrer ou à poser (au choix)
Inset or countertop sink

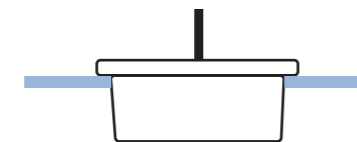

Installazione incasso
Installation inset
Installation à encastrer

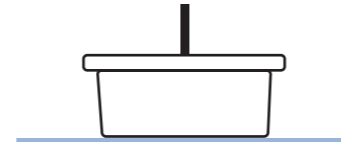

Installazione sopra il top di rifinitura
Installation over the top finishing
Installation au-dessus du top

SHINE HOLE 71

ART. LK19 - 71x51 cm - 19 kg



Lavello incasso/appoggio con foro rubinetto
Lavabo à encastrer ou à poser (au choix) avec trou pour robinet
Inset or countertop sink with tap hole

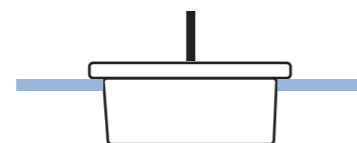

Installazione incasso
Installation inset
Installation à encastrer

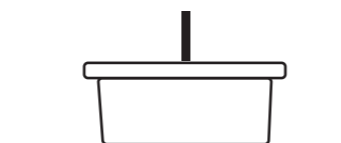

Installazione sopra il top di rifinitura
Installation over the top finishing
Installation au-dessus du top

TERRACOTTA



FINITURA:
TERRACOTTA ANTICA



TERRACOTTA



ART. LK20 - 55x43x h22 cm - 20 kg

Lavello vasca singola da incasso o appoggio in terracotta

Evier en terre cuite à encastrer ou à poser (au choix)

Inset or countertop terracotta sink



Installazione sopra il top di rifinitura
Installation over the top finishing
Installation au-dessus du top

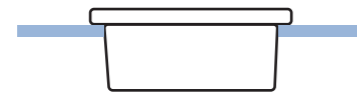

Installazione incasso
Installation inset
Installation à encastrer

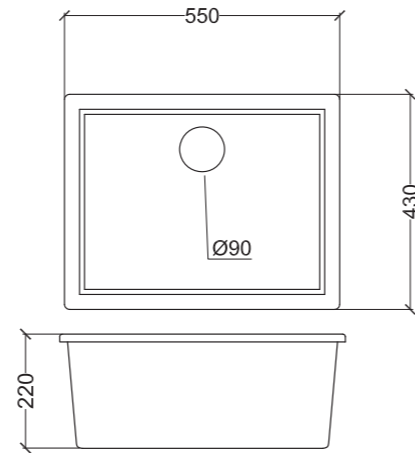

TERRACOTTA OVALE

ART. LK24 - 62x50x h18,5cm - 17 kg

Lavello ovale da appoggio in terracotta finitura int. opaca

Evier ovale terre cuite à poser finition intérieure terre cuite matt

Oval countertop terracotta sink matt terracotta inside

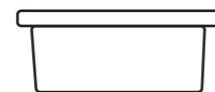

Installazione sopra il top
Installation over the top
Installation au-dessus du top

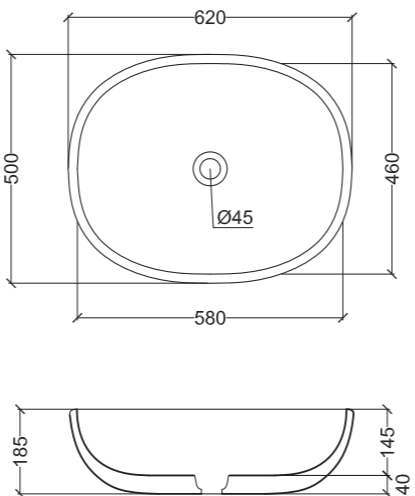

FINITURE TERRACOTTA

Terracotta finishes
Finitions terre cuite

TERRACOTTA:



TERRACOTTA ANTICA:

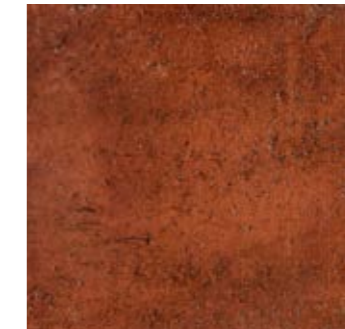

TERRACOTTA MATERICA:

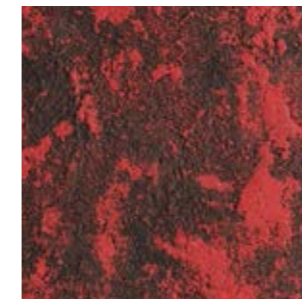

Rosso/Nero



Beige/Sabbia



Grigio cemento



Nero opaco

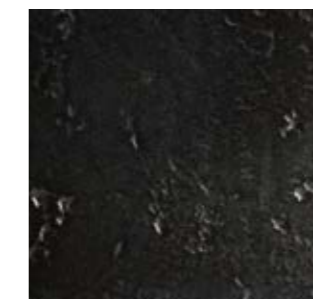

Nero piombico



Verde bottiglia



Rosso puro



Verde/Giallo



Verde prato



LIVIA

ITA Manufatti dal rame puro i nostri lavabi sono capolavori. La patina lucida è protetta per assicurare la tenuta del colore del rame. Il rame è anche un materiale duraturo e resistente alle corrosioni.

UK Handcrafted from pure copper, our sinks are a work of art. The mirror polish shine is protected to ensure they maintain their sumptuous gleam with a minimal maintenance. Our sinks are also extremely durable as copper is corrosion resistant.

FR Fabriqués à la main à partir de cuivre pur, nos évier sont des œuvres d'art. Leur brillance absolue est garantie par une protection appliquée qui permet de maintenir leur somptueux éclat avec une maintenance minimale. Nos évier sont aussi extrêmement durables dans le temps puisque le cuivre résiste à la corrosion.

LIVIA SINGLE



LIVIA DOUBLE



LIVIA SINGLE

ART. LVCPI0 - 56x48,5 cm - 12 kg

Lavabo vasca singola
Single sink
Lavabo simple vasque

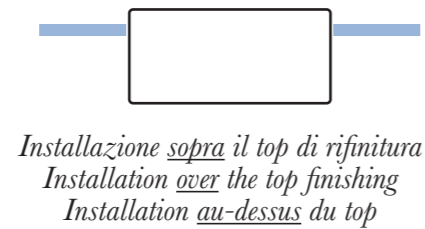

ITA 2 finiture disponibili: rame spazzolato o patina bronzo.

UK 2 finishes available: Brushed Copper or patine bronzée.

FR 2 finitions au choix: Cuivre Brossé ou patina bronze.

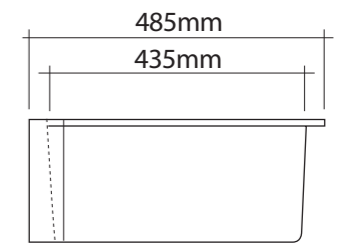
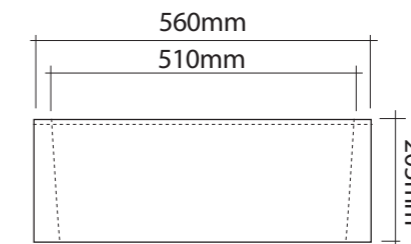
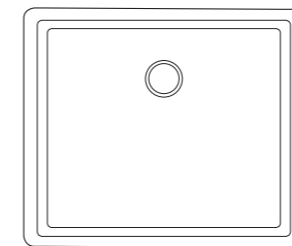

LIVIA DOUBLE

ART. LVCPI1 - 91,5x53,5 cm - 17 kg

Lavabo vasca doppia
Double sink
Lavabo double vasque

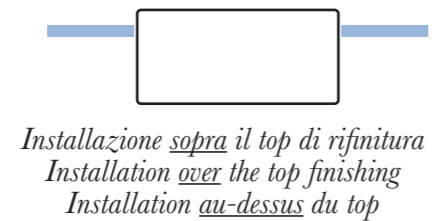

ITA 2 finiture disponibili: rame spazzolato o patina bronzo.

UK 2 finishes available: Brushed Copper or patine bronzée.

FR 2 finitions au choix: Cuivre Brossé ou patina bronze.

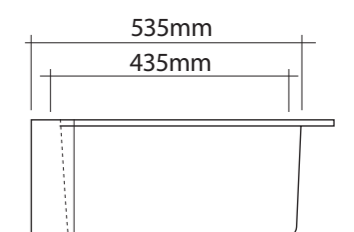
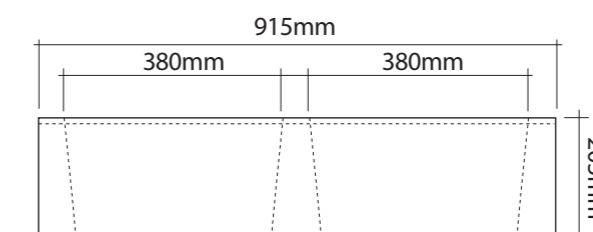
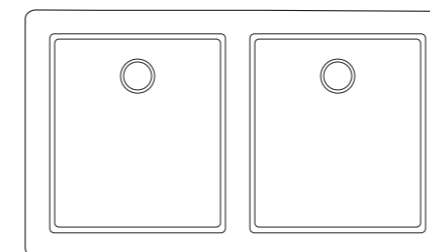



SABRI

ITA Manufatti dal rame puro i nostri lavabi sono capolavori. La patina lucida è protetta per assicurare la tenuta del colore del rame. Il rame è anche un materiale duraturo e resistente alle corrosioni.

UK Handcrafted from pure copper, our sinks are a work of art. The mirror polish shine is protected to ensure they maintain their sumptuous gleam with a minimal maintenance. Our sinks are also extremely durable as copper is corrosion resistant.

FR Fabriqués à la main à partir de cuivre pur, nos évier sont des œuvres d'art. Leur brillance absolue est garantie par une protection appliquée qui permet de maintenir leur somptueux éclat avec une maintenance minimale. Nos évier sont aussi extrêmement durables dans le temps puisque le cuivre résiste à la corrosion.

SABRI SINGLE



ITA 2 finiture disponibili: rame spazzolato o patina bronzo.
UK 2 finishes available: Brushed Copper or patina bronze.
FR 2 finitions au choix: Cuivre Brossé ou patine bronzée.

SABRI DOUBLE



ITA 2 finiture disponibili: rame spazzolato o patina bronzo.
UK 2 finishes available: Brushed Copper or patina bronze.
FR 2 finitions au choix: Cuivre Brossé ou patine bronzée.

SABRI

ART. LVCP08 - 56x48,5 cm - 10 kg

Lavabo vasca singola
 Single sink
 Lavabo simple vasque

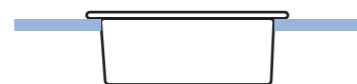

Installazione sopra il top di rifinitura
 Installation over the top finishing
 Installation au-dessus du top

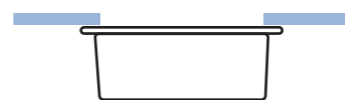

Installazione sotto il top di rifinitura
 Installation under the top finishing
 Installation au-dessous du top

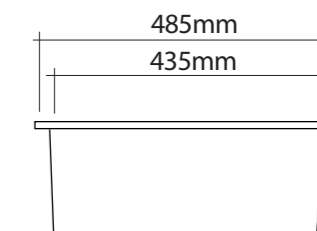
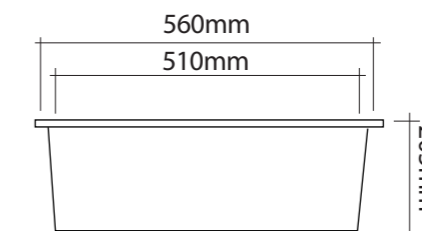
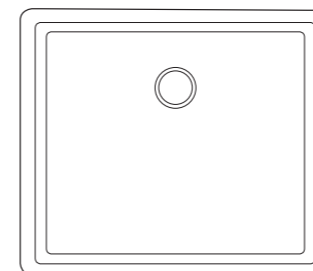

SABRI DOUBLE

ART. LVCP09 - 91,5x53,5 cm - 15 kg

Lavabo vasca doppia
 Double sink
 Lavabo double vasque

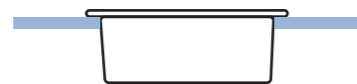

Installazione sopra il top di rifinitura
 Installation over the top finishing
 Installation au-dessus du top

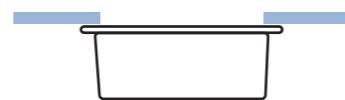

Installazione sotto il top di rifinitura
 Installation under the top finishing
 Installation au-dessous du top

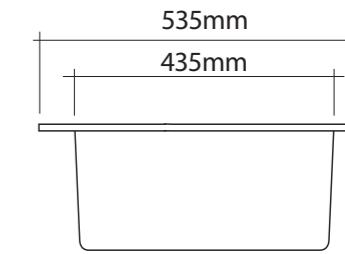
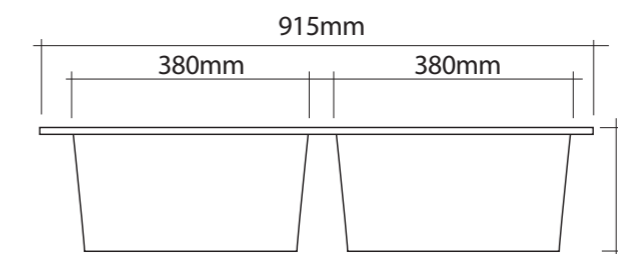
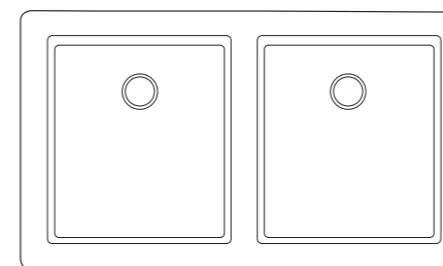

RUBINETTI

Taps
Robinets



COD. RKM08CT

Monoforo lavello con bocca girevole
Marguerite corten
One hole mixer tap with swivel spout corten
Robinet mélangeur monotrou avec col haut tournant corten



COD. RLF1042CR

Monoforo lavello bocca girevole
Fleur cromo
One hole mixer tap with swivel spout
Robinet mélangeur monotrou avec col haut tournant



COD. RLF1043CR

Monoforo lavello bocca girevole
Fleur cromo
One hole mixer tap with swivel spout
Robinet mélangeur monotrou avec col tournant



COD. RLA1044.2RM

Miscelatore lavello bocca girevole
Anis Rame
One hole mixer tap with swivel spout copper
Robinet mitigeur monotrou col haut avec col tournant cuivre



COD. RKA05BG

Monoforo lavello con doccia estraibile
Anis bronzo scuro
One hole mixer tap with pull out spout dark bronze
Robinet mélangeur monotrou avec douchette extractible bronze foncé



COD. RLA1044NS

Monoforo lavello Anis
nickel satinato
One hole mixer tap brushed nickel
Robinet mitigeur monotrou nickel mat



COD. RKM09CT

Rubinetto due fori lavello con bocca girevole
Marguerite Corten
Three holes mixer tap with swivel spout corten
Robinet mélangeur 3 trous avec col tournant corten



COD. RKM10CT

Batteria quattro fori lavello con bocca girevole e doccia estraibile
Marguerite Ral corten
Four holes mixer tap with pull out handset corten
Robinet mélangeur 4 trous avec douchette extractible corten



COD. RKF11BR

Rubinetto due fori lavello con bocca girevole
Fleur bronzo chiaro
Two holes mixer tap with swivel spout light bronze
Robinet mélangeur 2 trous avec col tournant



COD. RKF12OR

Rubinetto due fori lavello con bocca girevole
Croix oro chiaro
Two holes mixer tap with swivel spout light gold
Robinet mélangeur 2 trous avec col tournant or clair

RUBINETTI

Taps
Robinets



COD. RKMT16RAL

Monoforo lavello con bocca girevole
Metropolitan ral nero

*One hole revolving mixer tap with Metropolitan
handles and black finish*
*Robinet mélangeur monotrou tournant col haut noir
avec poignées Metropolitan*



COD. RKMT19RAL

Rubinetto Metropolitan murale tre fori con
placca in ral nero

Wall mounted mixer tap Metropolitan 3 holes
Robinet mélangeur mural trois trous Metropolitan



COD. RKMT18RAL

Miscelatore lavello bocca girevole
Metropolitan ral nero

*One hole revolving mixer tap with Metropolitan
handles and black finish*
*Robinet mitigeur monotrou tournant col
mi-haut noir avec poignées Metropolitan*



COD. RLF100MNK

Rubinetto con erogazione da
muro Fleur nickel

Wall mounted tap nickel
Robinet mural nickel



COD. RKA07ON

Rubinetto con erogazione da
muro Anis ottone naturale

Wall mounted tap natural brass
Robinet mural laiton naturel



COD. RKO02NS

Monoforo a muro con collo girevole Olive
nickel satinato

Wall mounted tap 1 hole with swivel spout brushed nickel
Robinet mural monotrou avec col tournant nickel mat



COD. RKA03ON

Miscelatore a muro con bocca distaccata
Anis ottone naturale

Wall mounted mixer tap 2 holes natural brass
Robinet mitigeur mural 2 trous laiton naturel



COD. RKM13RAL

Rubinetto a muro due fori con bocca fissa
Fleur ral nero mat

Wall mounted 2 holes mixer tap black finish
Robinet mural 2 trous noir



COD. RKF14BR

Rubinetto a muro due fori bocca
fissa Fleur bronzo chiaro

*Wall mounted two holes
mixer tap light bronze*
*Robinet mélangeur mural 2 trous
bronze clair*



COD. RKC15OR

Rubinetto a muro due fori bocca girevole Croix
oro chiaro

Wall mounted tap 2 holes with swivel spout light gold
Robinet mélangeur mural 2 trous avec col tournant or clair



COD. RKF01BG

Rubinetto a muro con collo girevole due
fori Fleur bronzo scuro

*Wall mounted two holes mixer tap with
swivel spout dark bronze*
*Robinet mélangeur mural 2 trous avec
col tournant bronze foncé*



COD. RKA06OR

Miscelatore a muro due fori bocca girevole
Anis oro chiaro

*Wall mounted mixer tap 2 holes with
swivel spout light gold*
*Robinet mitigeur mural 2 trous avec
col tournant or clair*



COD. RKA17NK

Miscelatore a muro due fori bocca girevole
Anis nickel

*Wall mounted mixer tap 2 holes with
swivel spout nickel*
*Robinet mitigeur mural 2 trous avec
col tournant nickel*



COD. RKA04OM

Batteria murale tre fori con bocca girevole
Anis oro matt

*Wall mounted three holes mixer tap with
swivel spout brushed gold*
*Robinet mélangeur mural 3 trous avec col tournant
or mat*



COD. RLF1016MON - cm 43xh12

Rubinetto murale tre fori Fleur con
placca ottone naturale

Wall mounted mixer tap 3 holes natural brass
Robinet mélangeur mural 3 trous laiton naturel



COD. RLC1015MBG - cm 43xh12

Rubinetto murale tre fori Croix
scatolato bronzo scuro

Wall mounted mixer tap 3 holes dark bronze
Robinet mélangeur mural 3 trous bronze foncé

ACCESSORI

Accessories
Accessoires



COD. AK001OR

Porta mestolo 60 cm con 10 ganci in oro chiaro
Utensile holder light gold
Porte ustensiles or clair



COD. AK002OR

Portatovaglioli in oro chiaro
Kitchen towel rack light gold
Porte serviettes de cuisine or clair



COD. AK003OR

Portarotolo da parete in oro chiaro
Wall mounted kitchen roll holder light gold
Porte Rouleau mural de cuisine or clair



COD. AK004OG

Porta rotolo da piano in oro scuro
Kitchen roll holder dark gold
Porte Rouleau de cuisine or foncé



COD. AK005CR

Griglia a muro alta cromo
Wall mounted grid in chrome finish
Grille murale haute chromée



COD. AK006ON

Griglia a muro bassa ottone naturale
Wall mounted grid in natural brass finish
Grille murale basse en laiton naturel



COD. AK007OR

Lampada da soffitto in oro chiaro e vetro
Ceiling lamp in light gold and glass
Lampe plafonnier en or clair et verre



COD. AK008

Piano in legno per lavabo Cook 91 Double
Wooden board for sink Cook 91 Double
Planche en bois pour évier Cook 91 Double



COD. RKPILOR

Piletta cucina a basket estraibile
Kitchen drain with strainer stopper
Bonde de cuisine avec grille extractible



COD. RLSIFCR

Sifone cromo
Syphon in chrome finish
Siphon en finition chrome



COD. RKA001BR

Rubinetto arresto gas Anis con placca quadrata bronzo chiaro
Gas shut off valve with square plate light bronze
Robinet d'arrêt du gaz avec plaque carrée bronze clair



COD. RKA002OR

Rubinetto arresto gas Anis con placca tonda oro chiaro
Robinet d'arrêt du gaz avec plaque ronde light gold
Gas shut off valve with round plate or clair

CURA DEI LAVELLI IN RAME

Copper sinks care
Entretien des éviers en cuivre

ITA Prendersi cura del proprio lavello in rame è davvero un compito facile, ma quotidiano. I lavelli in rame hanno il loro rivestimento protettivo chiamato patina. Questa finitura viva si trova naturalmente nel rame e nel tempo fornisce le sue proprietà antimicrobiche naturali che continueranno a cambiare ed evolversi nel tempo. E poiché il rame è un metallo vivo, lo scolorimento è inevitabile, ma ci sono modi per ridurre scolorimento e macchie naturali

CONSIGLI PER LA CURA DEL LAVELLO IN RAME:

- Pulire dopo ogni utilizzo con acqua tiepida, un detersivo per piatti delicato e un panno morbido o una spugna, ma assicurarsi di evitare prodotti chimici e detersivi aggressivi e abrasivi.
- Non utilizzare mai spugne abrasive, lana d'acciaio o qualsiasi altra spugna dura.
- Usare bicarbonato di sodio e acqua tiepida per rimuovere una macchia ostinata dalla superficie del lavandino.
- Asciugare il lavello dopo ogni utilizzo per evitare depositi minerali e macchie verdi.
- Rimuovere sempre i residui di cibo (soprattutto cibi acidi) e le stoviglie per evitare scolorimento temporaneo e graffi sulla superficie del lavello.
- Applicare a bisogno una cera o una protezione per il rame (o ogni volta che l'acqua non gocciola più sulla sua superficie) per schermare e lucidare la finitura del lavello in rame.

UK Taking care of your copper sink is an easy task but a daily one. Copper sinks have their own protective coating called patina. This living finish naturally occurs in copper, and over time, provides its natural anti-microbial properties which will continue to change and evolve over time. And because copper is a living metal, discoloration is inevitable but there are ways to reduce discoloration and natural spotting.

TIPS FOR COPPER SINK CARE:

- Clean after each use with warm water, a gentle dish soap, and a soft cloth or sponge but be sure to avoid harsh and abrasive chemicals and cleaners.
- Never use scouring pads, steel wool, or any other hard scrubbing pad.
- Use baking soda and warm water to remove a stubborn stain from your sink's surface.
- Dry your sink out after each use to prevent mineral deposits and green spotting.
- Always remove food debris (especially acidic foods) and dishes to prevent temporary discoloration and scratches to the sink's surface.
- Apply a copper protectant or wax monthly (or whenever water no longer beads on its surface) to shield and shine your copper sink's finish.

FR Prendre soin de votre évier en cuivre est une tâche facile mais quotidienne. Les éviers en cuivre ont leur propre revêtement protecteur appelé patine. Cette finition vivante se produit naturellement dans le cuivre et, au fil du temps, fournit ses propriétés antimicrobiennes naturelles qui continueront de changer et d'évoluer avec le temps. Et comme le cuivre est un métal vivant, la décoloration est inévitable mais il existe des moyens de réduire la décoloration et les taches naturelles.

CONSEILS POUR L'ENTRETIEN DES EVIERS EN CUIVRE :

- Nettoyez après chaque utilisation avec de l'eau tiède, un savon à vaisselle doux et un chiffon doux ou une éponge, mais assurez-vous d'éviter les produits chimiques et nettoyants agressifs et abrasifs.
- N'utilisez jamais de tampons à récurer, de laine d'acier ou tout autre tampon à récurer dur.
- Utilisez du bicarbonate de soude et de l'eau tiède pour enlever une tache tenace de la surface de votre évier.
- Séchez votre évier après chaque utilisation pour éviter les dépôts minéraux et les taches vertes.
- Enlevez toujours les débris alimentaires (en particulier les aliments acides) et la vaisselle pour éviter une décoloration temporaire et des rayures sur la surface de l'évier.
- Appliquez un protecteur de cuivre ou une cire tous les mois (ou chaque fois que l'eau ne perle plus sur sa surface) pour protéger et faire briller la finition de votre évier en cuivre.

DE Die Pflege Ihrer Kupferspüle ist eine einfache Aufgabe, aber eine tägliche. Kupferspülen haben eine eigene Schutzschicht namens Patina. Dieses lebendige Finish kommt auf natürliche Weise in Kupfer und mit der Zeit entfaltet sie ihre natürlichen antimikrobiellen Eigenschaften, die sich immer wieder verändern und weiterentwickeln. Und da Kupfer ein lebendiges Metall ist, ist eine Verfärbung unvermeidlich, aber es gibt Möglichkeiten, Verfärbungen und natürliche Flecken zu reduzieren.

TIPPS ZUR PFLEGE VON KUPFERSPÜLEN:

- Nach jedem Gebrauch mit warmem Wasser, einem milden Spülmittel und einem weichen Tuch oder Schwamm reinigen, vermeiden Sie jedoch scharfe und scheuernde Chemikalien und Reinigungsmittel.
- Verwenden Sie niemals Scheuerschwämme, Stahlwolle oder andere harte Schwämme.
- Verwenden Sie Natron und warmes Wasser, um hartnäckige Flecken von der Oberfläche Ihres Waschbeckens zu entfernen.
- Trocknen Sie Ihr Waschbecken nach jedem Gebrauch ab, um Mineralablagerungen und grüne Flecken zu vermeiden.
- Entfernen Sie immer Speisereste (insbesondere saurehaltige Speisen) und Geschirr, um vorübergehende Verfärbungen und Kratzer auf der Spülenoberfläche zu vermeiden.
- Tragen Sie monatlich (oder immer dann, wenn kein Wasser mehr auf der Oberfläche perlt) einen Kupferschutz oder ein Wachs auf, um die Oberfläche Ihrer Kupferspüle zu schützen und zu glänzen.



FINITURE METALLI

Metal finishing
Finition de métaux



RAL

Bianco
White
Blanc



CR

Cromo
Chrome
Chrome



NK

Nickel
Nickel
Nickel



NS

Nickel Satinato
Brushed Nickel
Nickel Mat



ON

Ottone Naturale
Natural Brass
Laiton Naturel



OR

Oro Chiaro
Light gold
Or Clair



OG

Oro Scuro
Dark Gold
Or Fonce



OM

Oro Mat
Brushed Gold
Or Mat



ORR

Oro Rosa
Gold Pink
Or Rose



RM

Rame
Copper
Cuivre



RS

Rame Satinato
Brushed Copper
Cuivre Mat



RA

Rame Antico
Old Copper
Cuivre Ancien



RAL

Nero 9005
Black 9005
Noir 9005



CT

Corten
Corten
Corten



NN

Nickel Nero
Black Nickel
Nickel Noir



NNS

Nickel Nero Satinato
Brushed Black Nickel
Nickel Noir Mat



BR

Bronzo Chiaro
Light Bronze
Bronze Clair



BG

Bronzo Scuro
Dark Bronze
Bronze Fonce

ITA Tutti i ns. prodotti in ottone si possono avere nelle seguenti finiture.
UK All our brass products can be done with the following finishes.
FR Tous les produits en laiton peuvent avoir les finitions suivantes.



TRUE COLORS KITCHEN DESIGNED BY EMANUELE PANGRAZI

Bleu
PROVENCE 

BLEU PROVENCE SRL
VIA MONTE CAMINETTO, 18
00060 SACROFANO ROME - ITALY
TEL.+39.331.9204888
WWW.BLEUPROVENCE.IT
info@bleuprovence.it

TRADEMARK REGISTRATO